

Industrial Videoscope PRM2830



Safety & Cautions	2
Getting started	4
[Part I] Product Outlook	5
1.1 PRM2830.....	5
[Part II] Main function	8
2.1 Live view screen UI	8
2.2 Live view screen overlays	8
2.3 Function buttons	9
2.4 Album	10
2.5 Album - Photo annotation function	13
[Part III] Setting menu	14
3.1 MAIN MENU	14
3.2 INFO	15
3.3 SESSION	17
3.4 TAG	18
3.5 WATERMARK	20
3.6 DATE / TIME	21
3.7 REPEAT RECORDING	21
3.8 AUTO POWER OFF	22
3.9 LANGUAGE	22
3.10 USB	23
3.11 SD CARD	25
3.12 MICROPHONE	25
3.13 IMAGE	26
3.14 DISTANCE	26
3.15 MICRO HDMI PORT	27
3.16 REGULATORY	27
SPECIFICATIONS	28
ACCESSORIES	29

Safety & Cautions

CE NOTICE

PRM2830 is in conformance with the following standards:

- 2014/30/EU Electromagnetic Compatibility Directive

FCC NOTICE

FEDERAL COMMUNICATIONS COMMISSION INTERFERENCE STATEMENT This equipment has been tested and found to comply with the limits for a Class B digital device, pursuant to part 15 of the FCC Rules. These limits are designed to provide reasonable protection against harmful interference in a residential installation. This equipment generates uses and can radiate radio frequency energy and, if not installed and used in accordance with the instructions, may cause harmful interference to radio communications. However, there is no guarantee that interference will not occur in a particular installation. If this equipment does cause harmful interference to radio or television reception, which can be determined by turning the equipment off and on, the user is encouraged to try to correct the interference by one or more of the following measures:

- Reorient or relocate the receiving antenna.
- Increase the separation between the equipment and receiver.
- Connect the equipment into an outlet on a circuit different from that to which the receiver is connected.
- Consult the dealer or an experienced radio / TV technician for help.

CAUTION:

Any changes or modifications not expressly approved by the grantee of this product could void the user's authority to operate the product.

RoHS NOTICE

PRM2830 is in conformance with the requirements of the European law on the Restriction of Hazardous Substances (RoHS) directive. This means that our product is both lead-free and without the hazardous substances either in the manufacturing process or in the final product.

SAFETY GUIDE

USER MUST PAY ATTENTION TO THE INFORMATION PROVIDED HERE TO ENSURE SAFETY.

We suggest you read the following statements carefully before using the product. If the product is used in a manner not specified by the manufacturer, the protection provided by the product may be impaired.

CAUTION If this product is used without observing the information given under this symbol, it might cause damage to this product.

CAUTION BATTERY

- Risk of explosion if battery is replaced by an incorrect type.
- Dispose of used batteries according to the instructions.
- Never replace the battery by yourself.

CAUTION CERTAIN SUBSTANCES MAY DAMAGE THE PROBE

- Please refer to chemical resistance below. Contact the store you purchased for unsure chemical solutions for further information.

Chemical Resistance:

- Water
- Brake fluid
- Gasoline
- Diesel fuel
- Transmission fluid

WARNING If this product is used without observing the information given under this symbol, it might cause injuries or loss of life.

WARNING HAZARD ENVIRONMENT

- Do not use this product in explosive environments such as gasoline or alcohol storage tank.

CAUTION This product does not support probe hot swap. Please always connect the compatible probe properly before switch on.
Switch off the product before changing the probe.

WARNING FLAMMABLE GASES

- Do not use this system near flammable gases.

WARNING INDUSTRIAL USAGE ONLY

WARNING INTENSIVE LIGHT MAY CAUSE EYE INJURY

- Avoid looking at the camera head while LED is on.

Getting started

1. Ensure that a micro SD card is inserted in the slot.
2. Carefully connect the camera probe as detailed below:

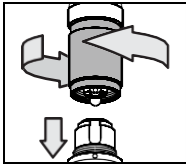

- (1) Align the white dots printed on the probe and monitor's connector.
- (2) Carefully plug the probe into the monitor.
- (3) Tighten the connecting collar to secure the probe connection.

** Connecting the probe to the monitor.

Long press the power button, the logo will appear. The camera image will then appear.

If the battery status icon is showing a low, or if the monitor will not power up, connect the PRM2830 to an AC power source using the supplied AC adapter / charger.

If the screen freezes, press the rest button for 2 seconds. Long press the power button to power on the PRM2830 after the reset.

Long press the power button to switch off the PRM2830 after use.

[Part I] Product Outlook

- 1.1 X600

Power



Microphone

Magnetic tilt stand

Reset

Micro SD port

Micro HDMI port

USB-C port



- Hinge dock: The hinge performs attachable bolt nut for holding the screen unit. It allows pan and tilt operation to provide user a best eye view angle.

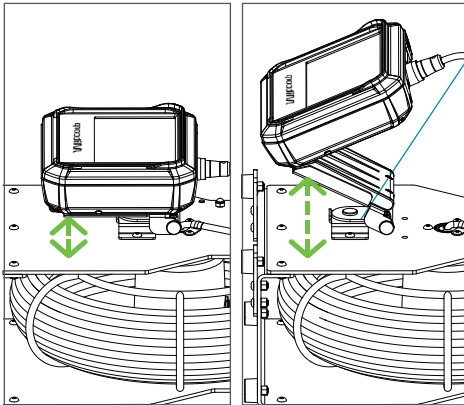

Lie down / lift-up mode.
The maximum height is restricted by the cable angle.

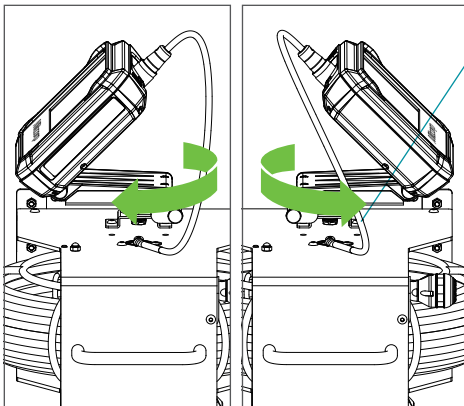

Right / left rotation dock. The maximum rotation angle is about 180 degree(right 90+left 90).

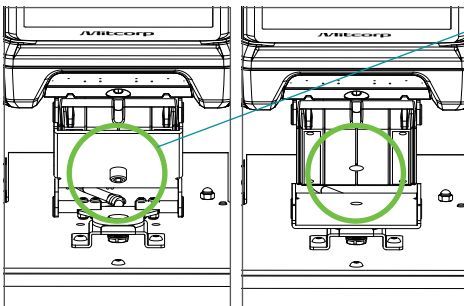

Imperial 1/4-2UNC bolt and washer are attached the screen back stand. Use a hex wrench to disassemble it form the dock if needed. The back stand embedded magnet allows attachment to steel surfaces.

- Maintain & Care

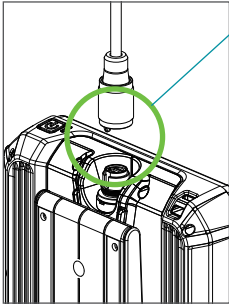

There is a USB type-C inside the screen unit connector. In some cases user may need the re-connect it. Be sure to align the white dot of side, push and screw tightly and check the image signal runs properly.

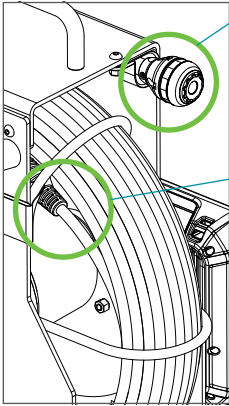

The camera tip holder. Every time finish using, be sure to roll back the tube till the camera tip been clipped on the holder properly.

After, uses the tape to fix the reel to avoid accidentally withdraw/rolling movement.

[Part II] Main function

- 2.1 Live View screen UI

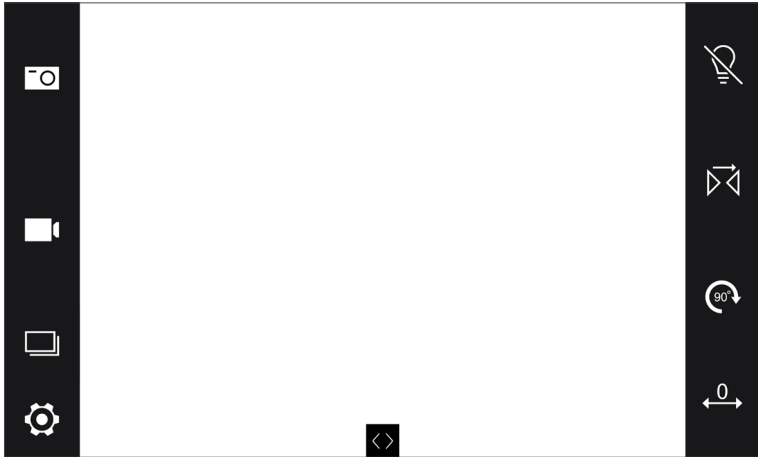









- 2.2 Live view Screen Overlays



• 2.3 Function Buttons









List as follows:

Items	Button	Description
Snapshot		Save the live-view picture in the SD card. Snapshot can be done during recording and video playback.
Recording		Record videos in the SD card.
Album		Access the SD card to review images and videos been saved.
Setting		Setting menu.
Brightness		LED light on/off.
Mirror image		Tap to show a mirror image from the camera view.
Rotate image		Tap to rotate image clockwise (90°, 180°, and 270°).
Meter reset		To reset the meter. Generally when the camera tube is pulled out and ready to insert into the tube, you should reset the meter to 0 to get right insert length data.
Full screen		Full screen live view switch.
Zoom in/out		Pinch-To-Zoom.
Power button		Power on/off.
LED indicator		“power on-green” -> battery high “power on-red” -> battery low “power on-orange” -> charging “power off-red” -> charging “power off-none” -> full charged.

• 2.4 Album

- Photo album: The system list latest file in the order of right-down. When there are different date fields in the same page, the first file will be marked a yellow date code.



Button	Items	Description
	Back	Go back to live view.
	Session	Go to access SESSION folders or edit mode.
	Compare image	Refers to the <u>Compare function</u> ^{*1} bellows for details.
	Photo album	Indicate now under photo album. Tap to go to video album.
	Video album	Indicate now under video album. Tap to go to photo album.
	Delete select	Select files to be deleted.
	Delete file	Confirm deleting selected files.
	Page up	Album page forward.
	Page down	Album page backward.

- Single photo view

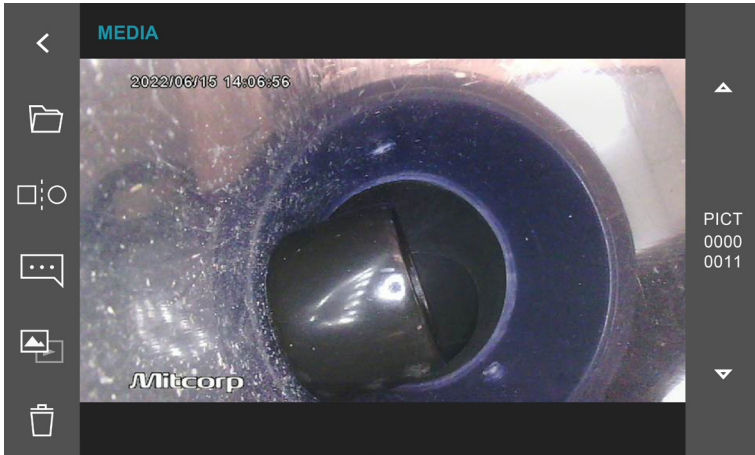

(*1) **Compare function:** To compare a stored image (target flaw or golden sample) with the live view on a split screen. In album mode, tap the icon then select an image then the screen will split as showing the stored image on the right and the live view on the left.





1. Move - move the stored image to the target position.
2. Switch - switch the images from right to left.
3. Replace - replace the stored image to another stored image.
4. Tap the compare icon button will go back to normal live view.

- Video album: The system list latest file in the order of right-down. When there are different date files in the same page, the first file will be marked a yellow date code.



- Single video playback







Button	Items	Description
	Play	Start to play back the video. Touch the screen can play / pause while playback.
	Screenshot	During video playback, tap to screenshot real-time image at any moment.
	Photo album	Indicate now under photo album. Tap to go to video album.

- 2.5 Album - Photo annotation function

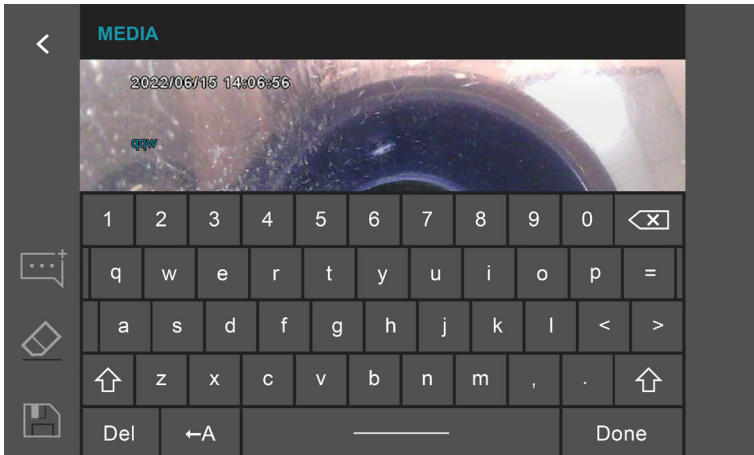
The PRM2830 system allows user add maximum 10 notes on a photo. Each note can key in maximum 24 characters. The edit steps as follow:

Tap the comment icon and type a comment using the touch-screen keyboard that appears; Tap DONE on the keyboard when finished.



Items	Button	Description
Add Note		[key in]-> [Done]. Then a note can be done. Move note position: Touch any note been made on screen then it shows a green frame. The note frame can be dragged to any position you want to mark on the photo.
Erase Note		Tap a note note been made on screen then it shows a green frame. Delete notes by tapping the eraser.
Save		Tap to save the comments with the photo. The original photo will not be covered.

[Part III] Setting menu

- 3.1 MAIN MENU

Including 14 setting items in 2 pages.

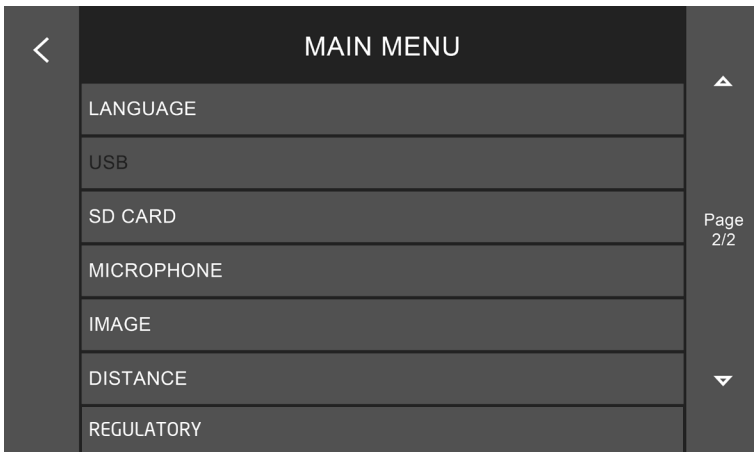
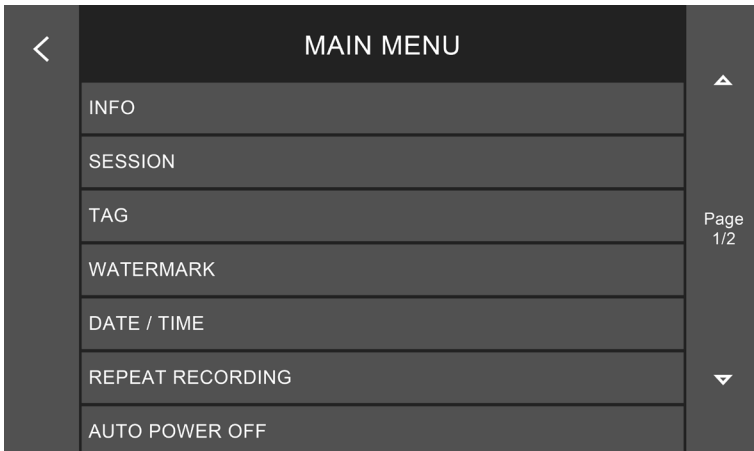

- 3.2 INFO.

Include firmware information.

- Current hardware and firmware version.

Firmware upgrade: When there is a new version firmware be suggested, save the file (.BRN file format) in the SD card root dictionary.

1. Tap the ">" button up-right the screen.



2. Follow the instruction.

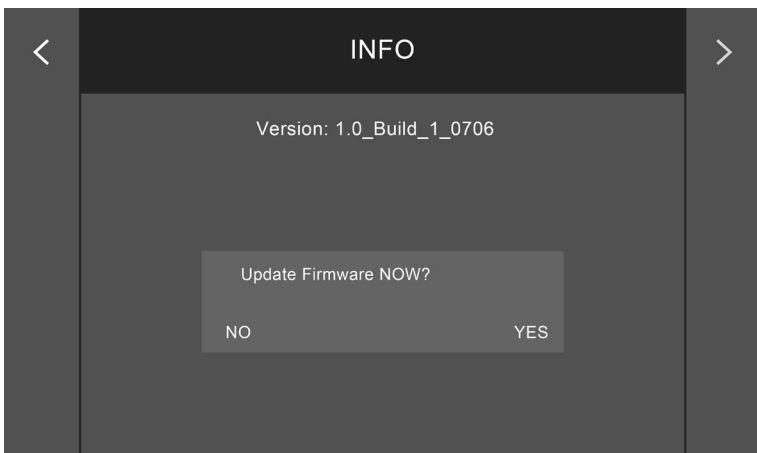

3. The system will automatically shut down when the upgrade is done. Reboot the system then check if new version is properly installed.

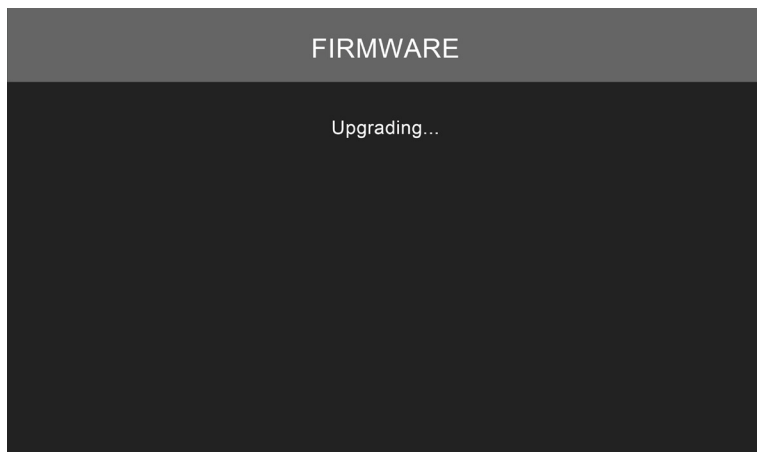

• 3.3 SESSION

PRM2830 provides custom build photo / video storage folder under SESSION. When a new SD card is installed, the default folder-MEDIA will be built.

The edit steps as follows:

Add & Edit a new folder

Jump to TAG under selected folder

Delete selected folder

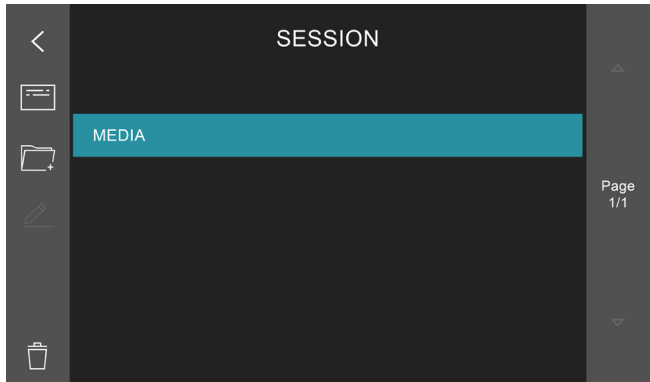

Edit folder title

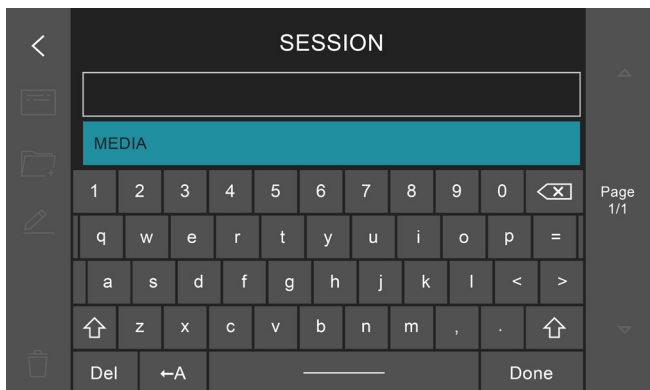

Finish editing

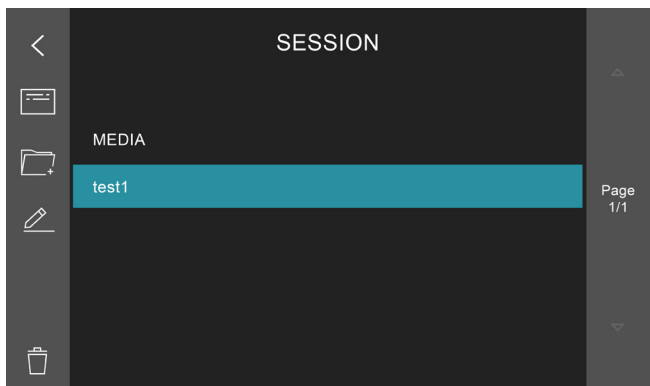

• 3.4 TAG

PRM2830 provides custom build photo / video storage folder under TAG. When a new SD card is installed, the default folder-MEDIA will be built.

The edit steps as follows:

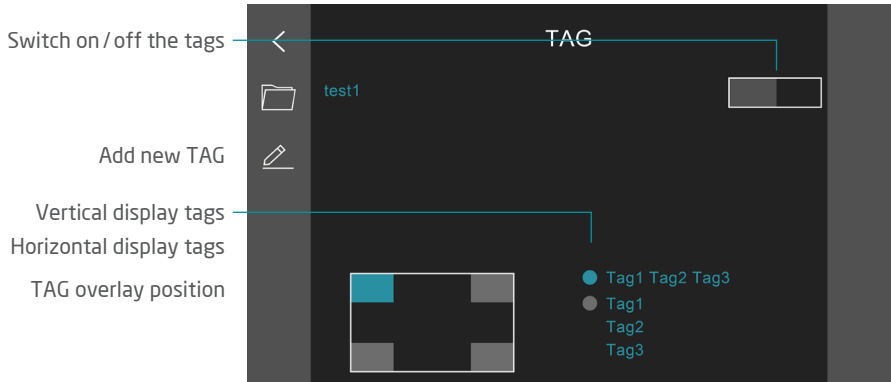

Tap 'ADD' pop-up keypad

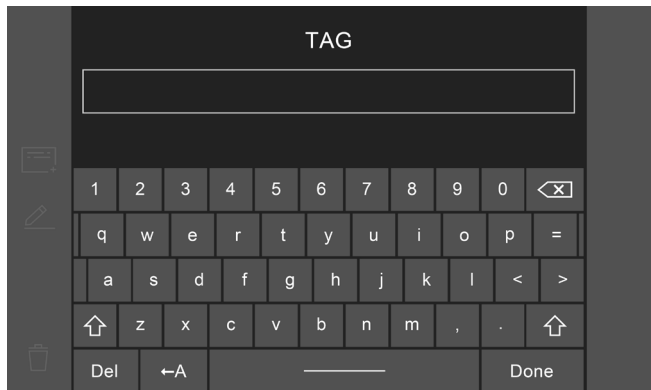

Delete selected tag

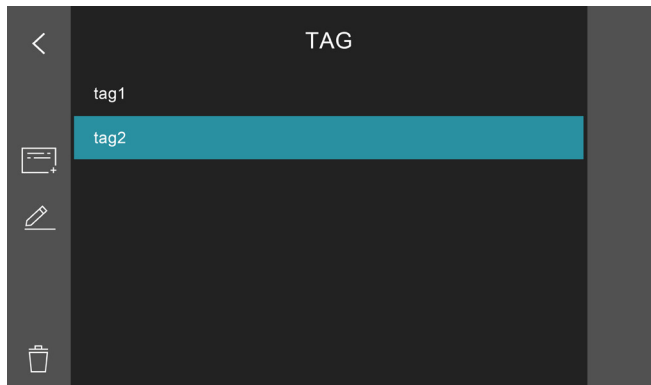

<Note>

- SESSION and TAG custom setting are saved in system internal memory. All edit mention above need to be done on PRM2830. You cannot edit the SD card via any other PCs to get the same result.
- When you replace another SD card, the custom SESSION and TAG will be automatically load on. If the SD card has same folder name inside already, then that folder will be hired directly. Other data / files in that SD card will not be changed or moved at all.

- 3.5 WATERMARK

- On / off switch for timestamp and watermark overlays on snapshot.
- Timestamp and watermark position are adjustable to 4 corners of the photos.

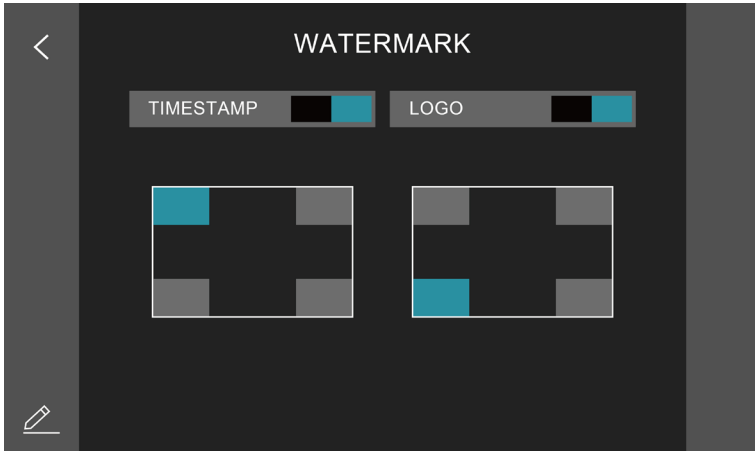

- The watermark logo can be replaced a follow steps:
 - 1 Save logo file in SD card on root directory.
File format: 160*160 resolution; .JPG; black background (RGB-0.0.0.) Name the file as WATERMARK.
 2. System will show the exiting file list below. Tap the file then the “save” icon to load it into system memory.
The logo show in the right side preview window.
 3. (“CUSTOM” as the sample case) when the processes are properly done.
Tap the preview window to enable custom watermark.

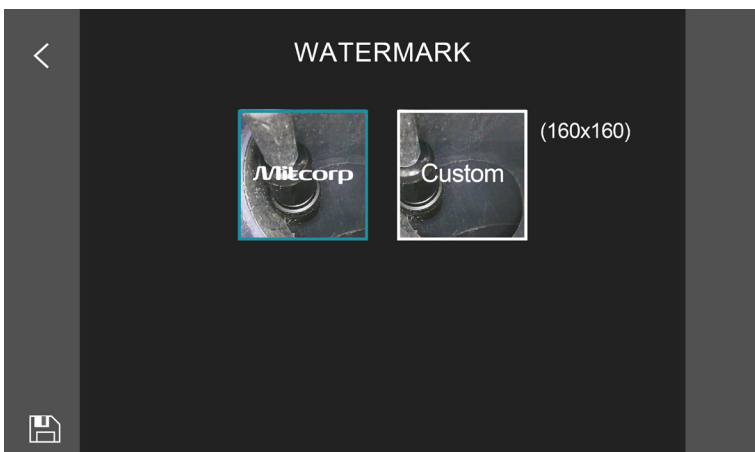

- 3.6 DATE / TIME

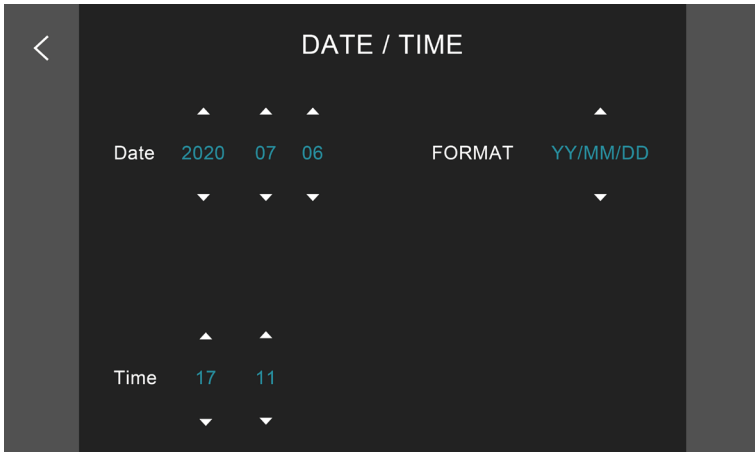

- 3.7 REPEAT RECORDING

The system provides 4 modes of repeat recording length. When disable this function, the system will set as 20 minutes none repeat recording.

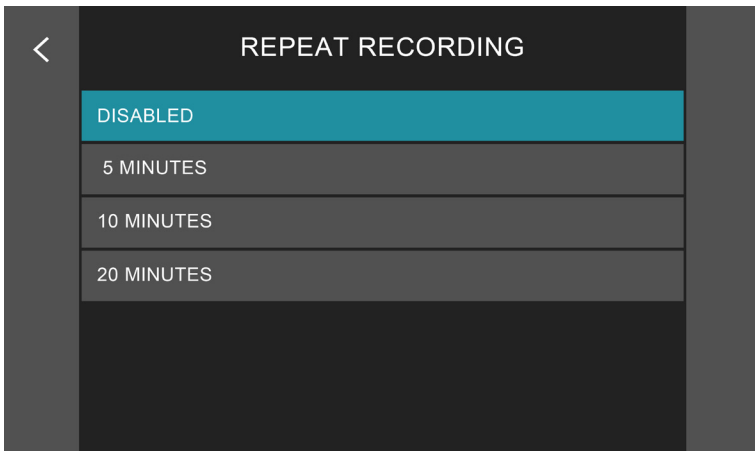

- 3.8 AUTO POWER OFF

4 modes of auto power off settings.

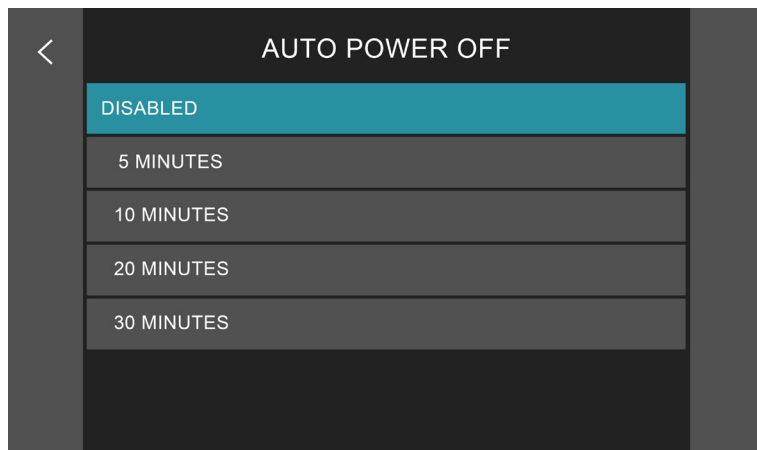

- 3.9 LANGUAGE

Support 28 languages.

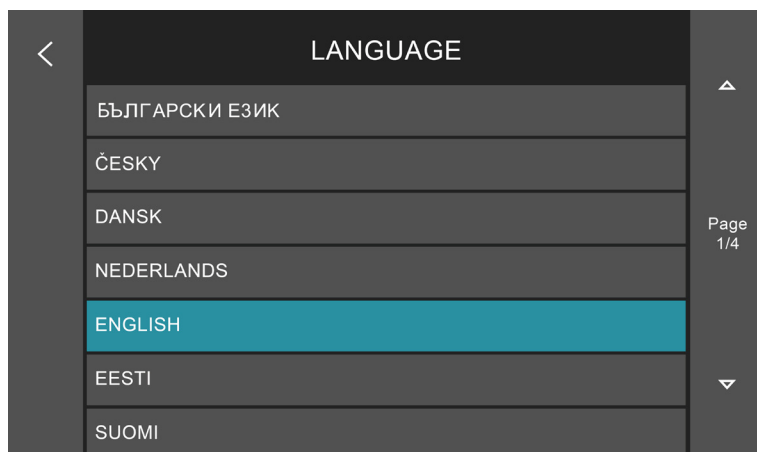

- 3.10 USB PORT

- When the USB port is connected to the PC, select the desired output: (1) SD card reader (2) Camera.

(1) SD card reader: Please select READER.

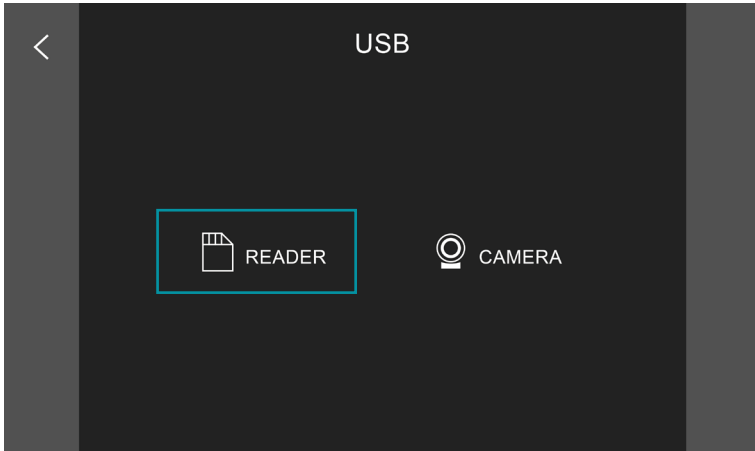

(2) Camera: The live image can be viewed on a video monitor or connected to a PC show the inspection via online meeting app for real-time sharing.

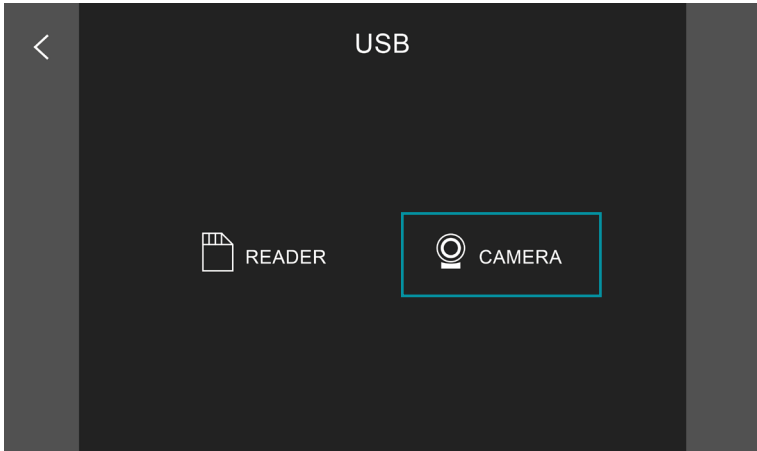

1. Webcam mode

The live image can be viewed on a video monitor or connected to a PC show the inspection via online meeting app for real-time sharing. Connect the PRM2830 to PC and log on the online meeting app, select the PRM2830 as the camera from setting. The PC will share the same inspection view on the PRM2830. Support Google Meet, Zoom, Microsoft Teams, Skype.

- 3.11 SD CARD

Show the SD card storage status, delete, and format functions.

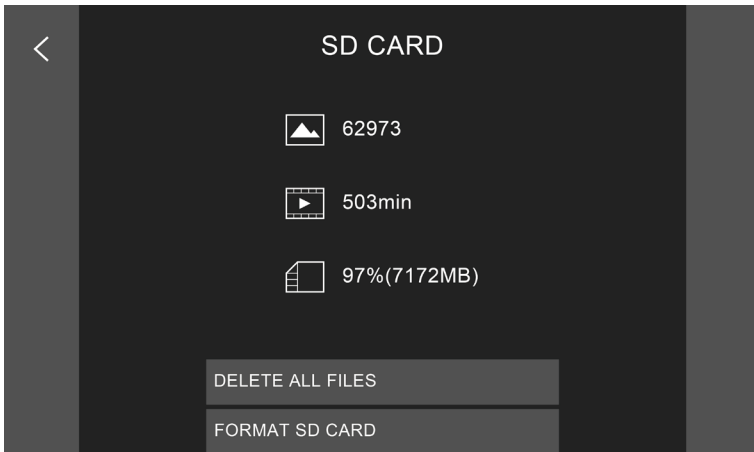

- 3.12 MICROPHONE

Switch on / off voice recording while recording videos.

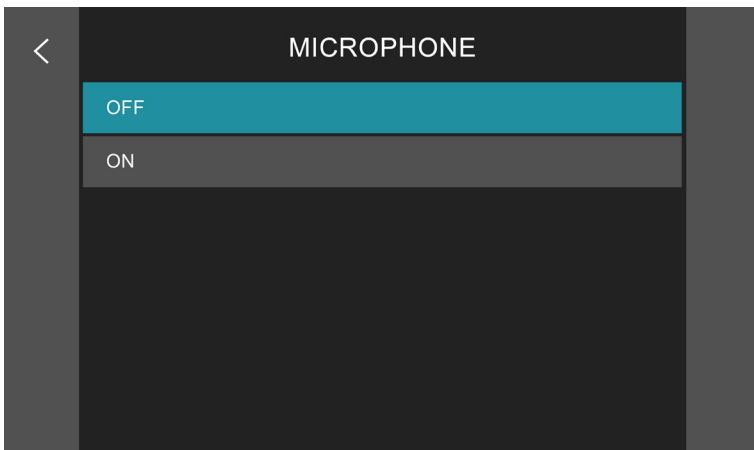

- 3.13 IMAGE

The system provides 3 fine tune parameters and DEFAULT function.

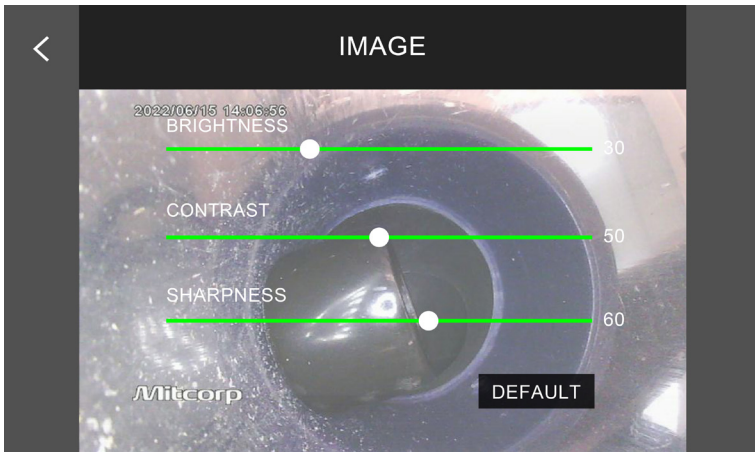

- 3.14 DISTANCE

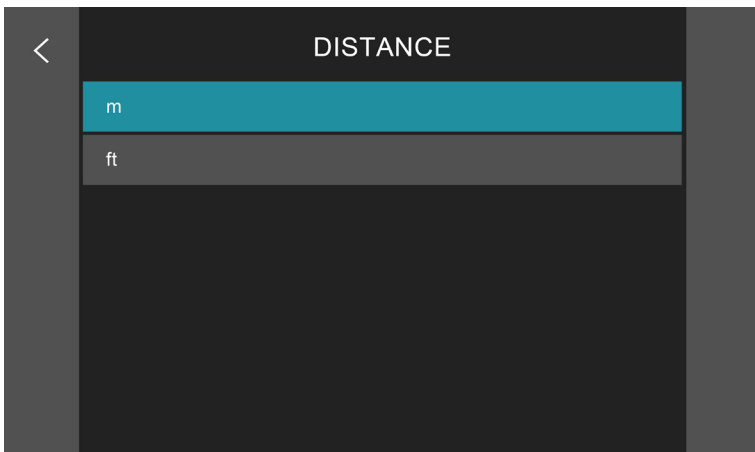

- 3.15 MICRO HDMI PORT

For viewing images from an external monitor.

Connect PRM2830 on the micro HDMI port with supplied HDMI cable to an external monitor. Switch on PRM2830 then switch on the external monitor.

- 3.16 REGULATORY

Here reveals the safety compliance of this product.



SPECIFICATIONS

PRM2830

Model	X600 Monitor
Dimension	161.93 (mm) * 127.93 (mm) * 46 (mm)
Weight	705g
Display	5" Touchscreen 800*480 pixels
Power supply	Rechargeable Li-battery
Video output	Micro HDMI
Working time	Approximately 3.5 hours of operation
Charging time	Approximately 2.5 hours
Data transfer / Charging	USB-C
DC Power adapter	Input:100-240V~0.5A; Output: 5V/3A(15W)
Phone Jack	Built-in microphone
Storage	Micro SD up to 64GB
Image Format	JPEG, 1920*1080
Video Format	MP4, 1920*1080
IP Rating	IP54
Drop resistance	1 meter
Operating temp.	-10°C~50°C
Storage temp.	Generally storage under 60°C. If idle for more than 3 months, it is strongly recommended to keep under 20°C and dry environment
Charging temp.	0°C~40°C

Probe

Model	2830HD-F-30M-FRP
Diameter	28 mm
Length	30 m
Direct of view	Front view
Illumination	Front LEDs
FOV (Field of View)	150°
DOF (Depth of Field)	20 mm~∞
Probe head material	Stainless steel
Buttons	Full touch screen. No physical button
Material	FRP
Liquid resistance	Unleaded gasoline, diesel, machine oil, brake oil, transmission oil, water
IP rating	IP68
Working temp.	-10°C~60°C
Storage temp	Generally storage under 60°C. If idle for more than 3 months, it is strongly recommended to keep under 20°C and dry environment
Relative humidity	Max 95% non-condensing

ACCESSORIES

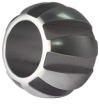

Ø50 mm metal ring
(Optional)



Ø100 mm brush
(Optional)



Ø150 mm brush
(Optional)



Carry case



DC Adaptor



USB cable



HDMI cable



Micro SD card

MAY.2024